

厚紙に貼って切り、⑪北側(大)の補強にする

厚紙に貼って切り、⑭南側(大)の補強にする

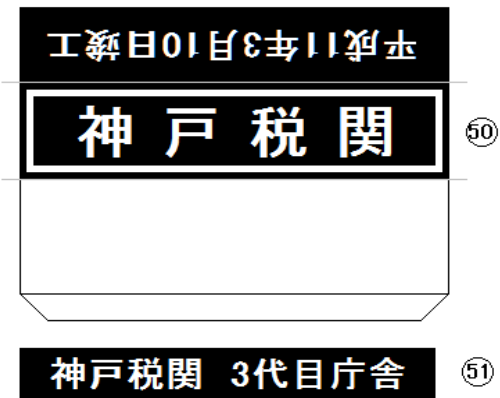

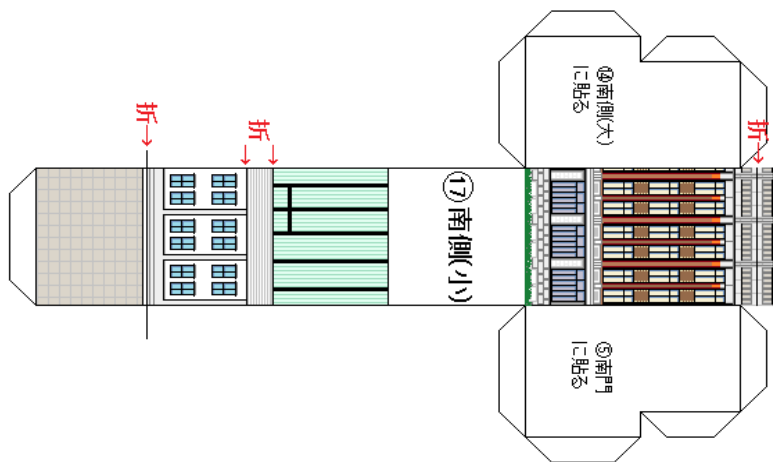
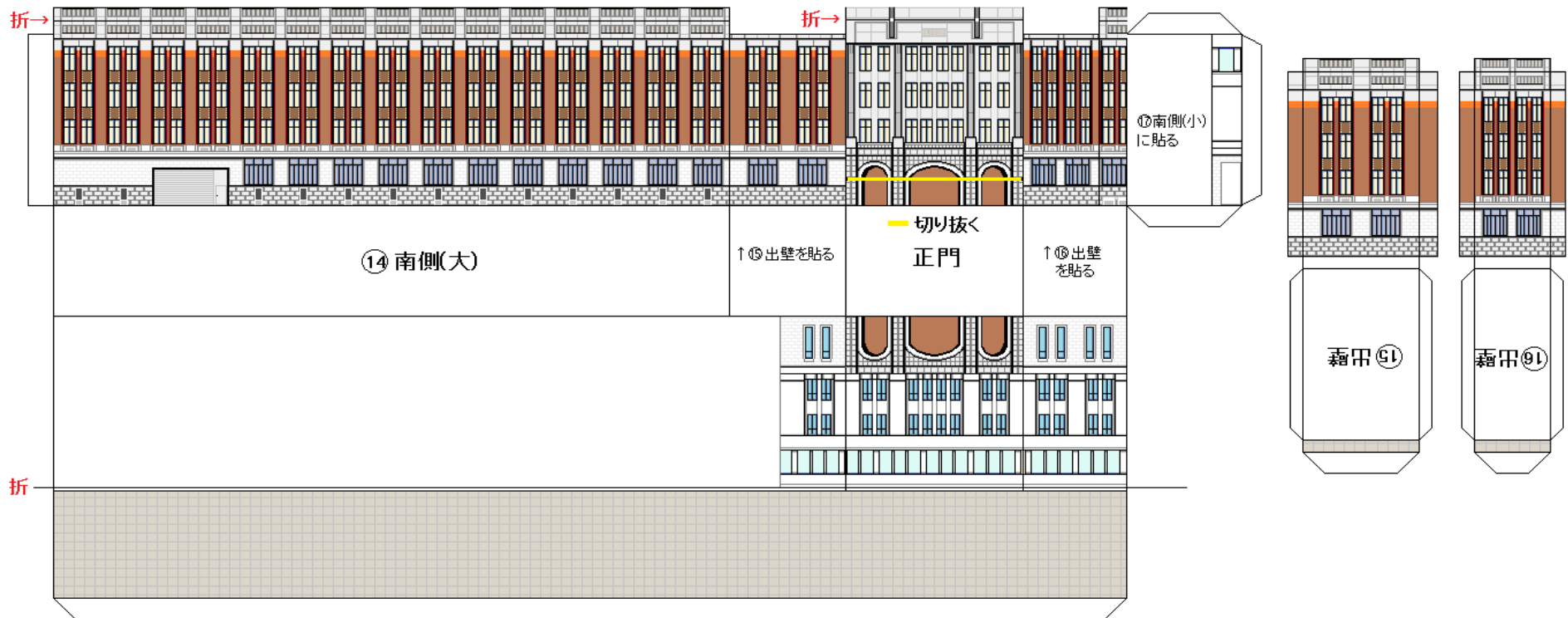
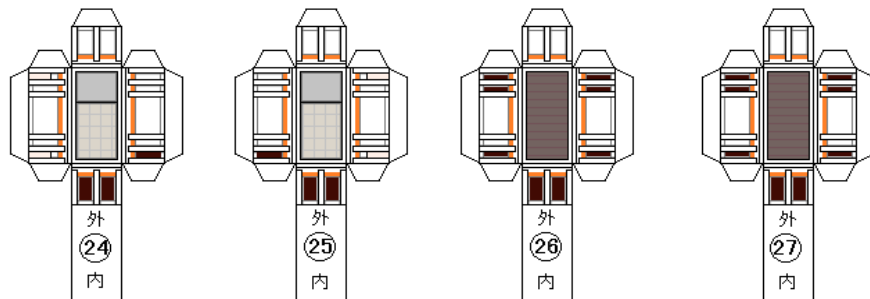
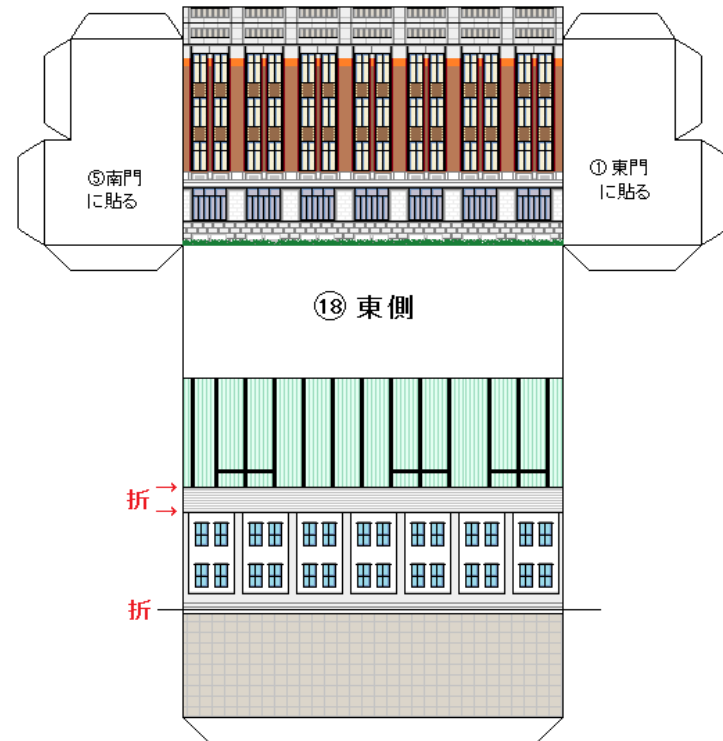
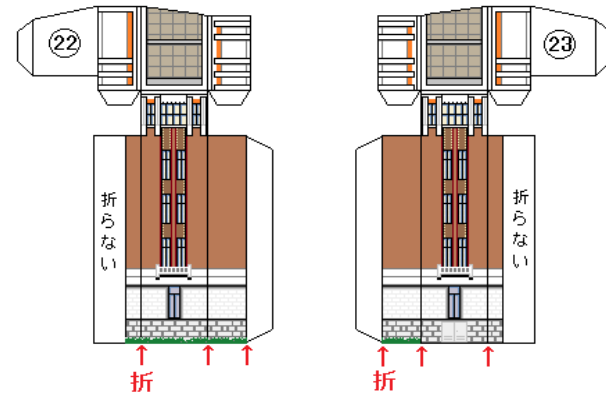
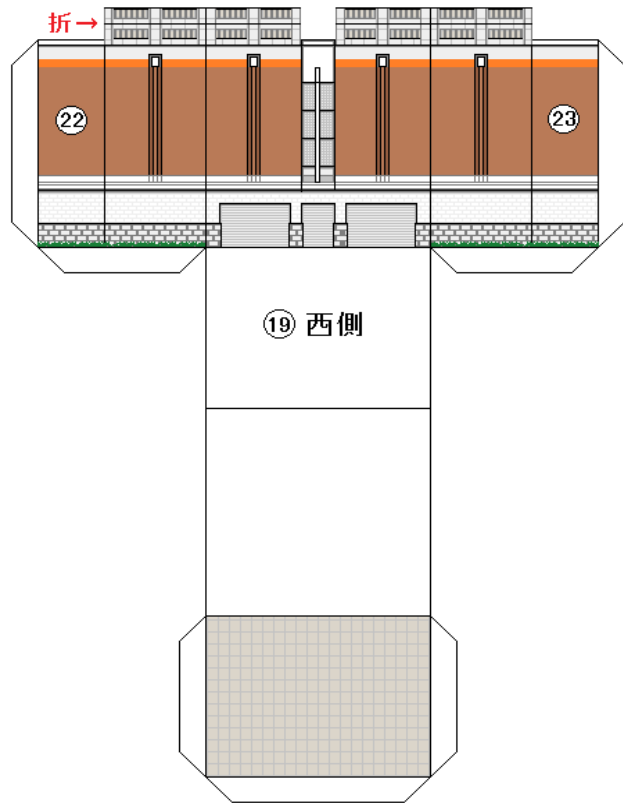

上部構造物

⑳ 屋上

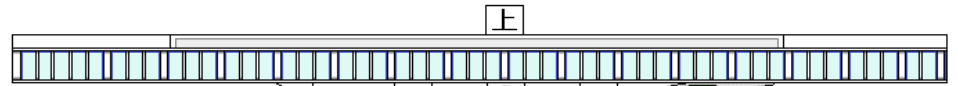
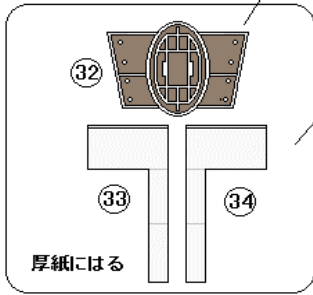
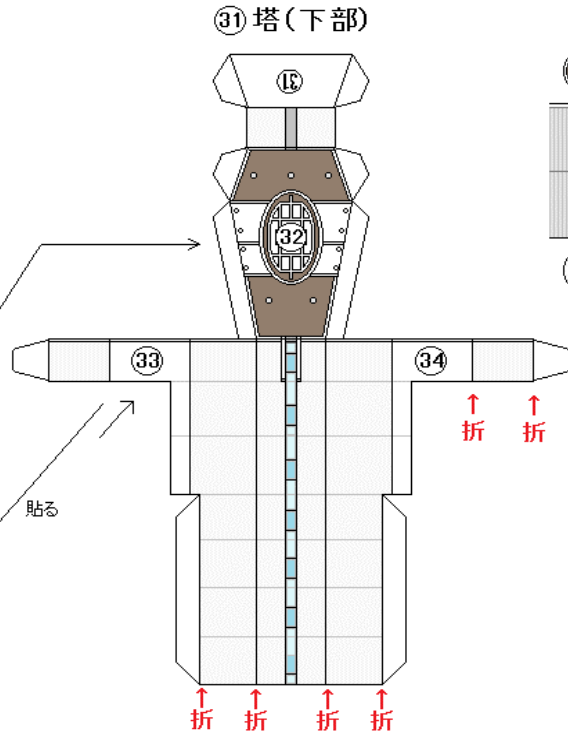
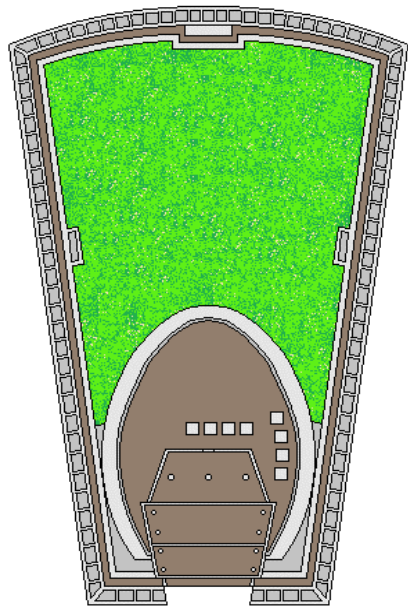

㉕ 4階植込み

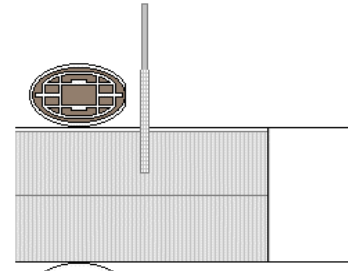

㉖ 塔(上部)

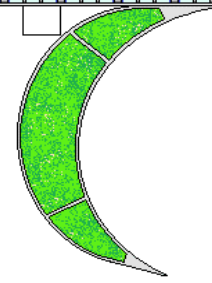

㉗ 税関旗

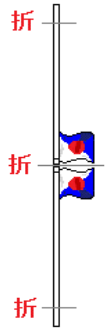

切り抜く

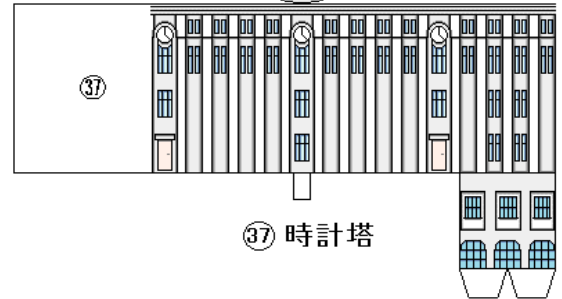

㉘ 時計塔

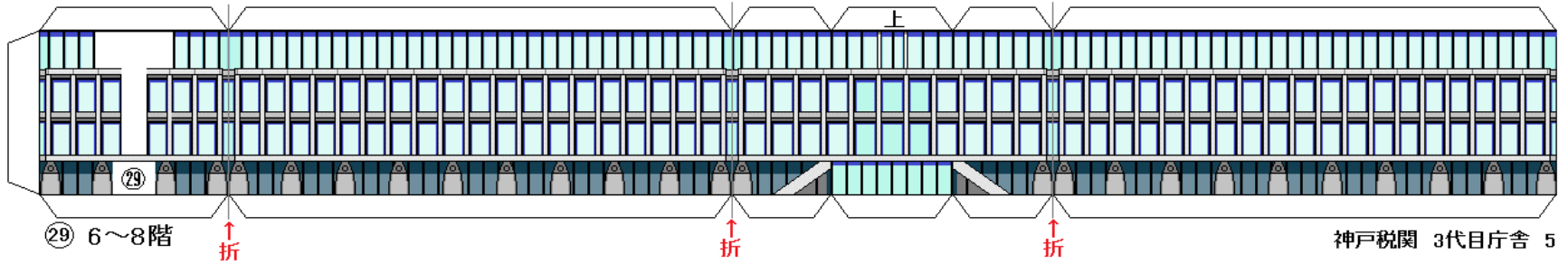

㉙ 6~8階

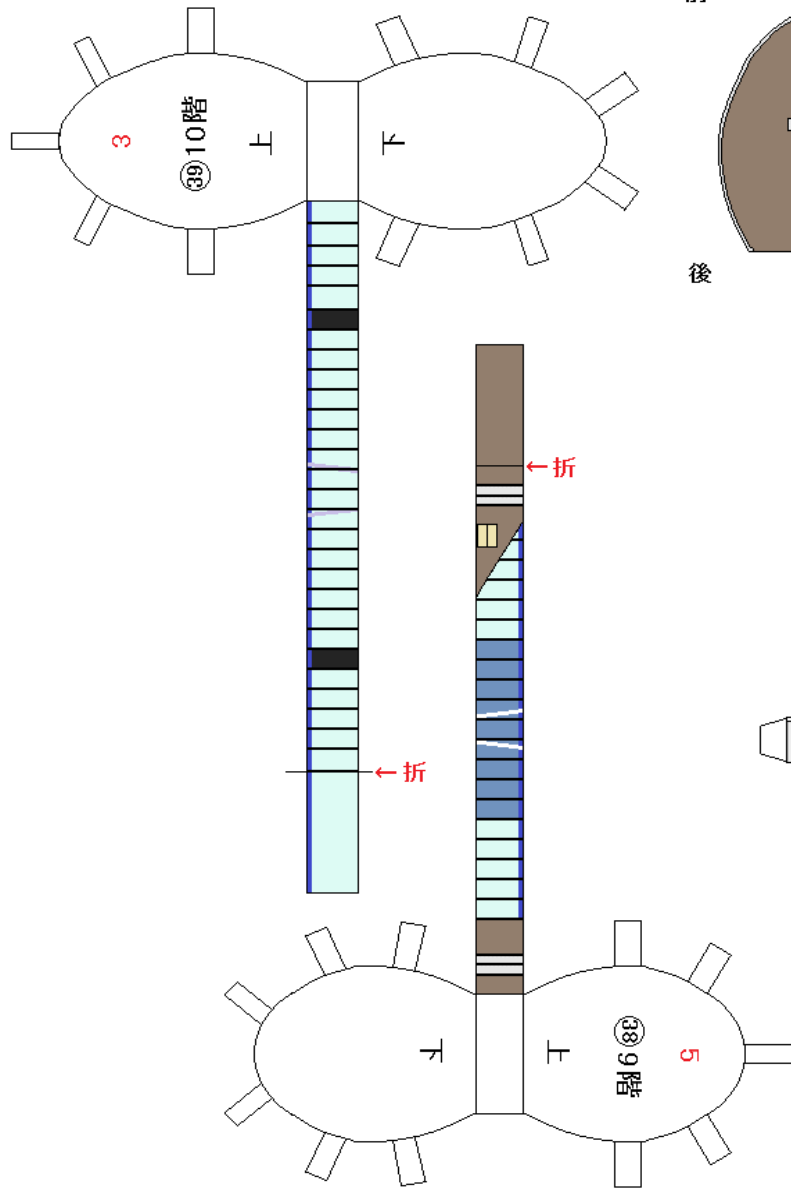

前

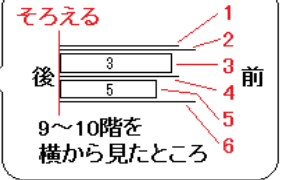
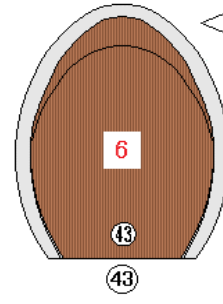
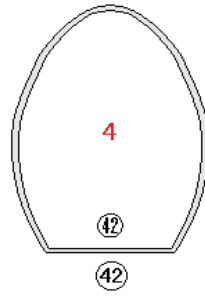
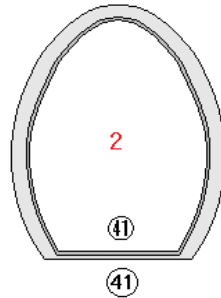
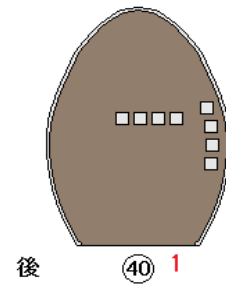

後

